

BAT46X SCHOTTKY BARRIER DIODE

FEATURES

- High breakdown voltage
- Low turn-on voltage
- Guard ring construction for transient protection

MARKING: S9

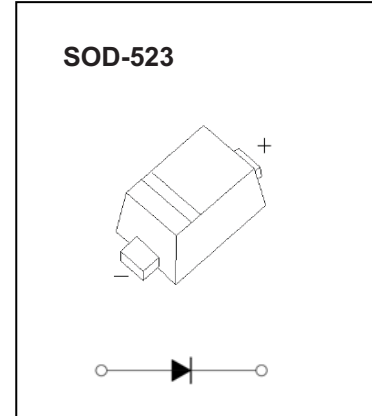
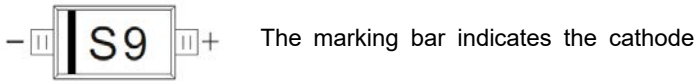

Maximum Ratings @Ta=25°C

Parameter	Symbol	Limit	Unit
Peak repetitive peak reverse voltage	V_{RRM}	100	V
Working peak reverse voltage	V_{RWM}		
Forward continuous current	I_F	150	mA
Repetitive peak forward current (Note 1) @ $t_p < 1.0s$, Duty Cycle < 50%	I_{FRM}	350	mA
Non-repetitive Peak Forward surge current @ $t = 8.3ms$	I_{FSM}	750	mA
Power dissipation	P_D	150	mW
Thermal resistance junction to ambient air	$R_{\theta JA}$	667	°C/W
Operating Junction Temperature Range	T_J	-40 ~ +125	°C
Storage Temperature Range	T_{STG}	-55 ~ +150	°C

ELECTRICAL CHARACTERISTICS (Ta=25°C unless otherwise specified)

Parameter	Symbol	Test Conditions	Min	Typ	Max	Unit
Reverse breakdown voltage(Note 2)	V_R	$I_R = 100\mu A$	100			V
Reverse voltage leakage current	I_R	$V_{R1} = 1.5V$			0.3	μA
		$V_{R2} = 10V$			0.5	
		$V_{R3} = 50V$			1	
		$V_{R4} = 75V$			2	
Forward voltage(Note 2)	V_F	$I_{F1} = 0.1mA$			0.25	V
		$I_{F2} = 10mA$			0.45	
		$I_{F3} = 250mA$			1	
Diode capacitance	C_T	$V_R = 0, f = 1MHz$		20		pF
		$V_R = 1V, f = 1MHz$		12		

Notes: 1. Part mounted on FR-4 board with recommended pad layout.
2. Short duration pulse test used to minimize self-heating effect.



Typical Characteristics

Forward Characteristics

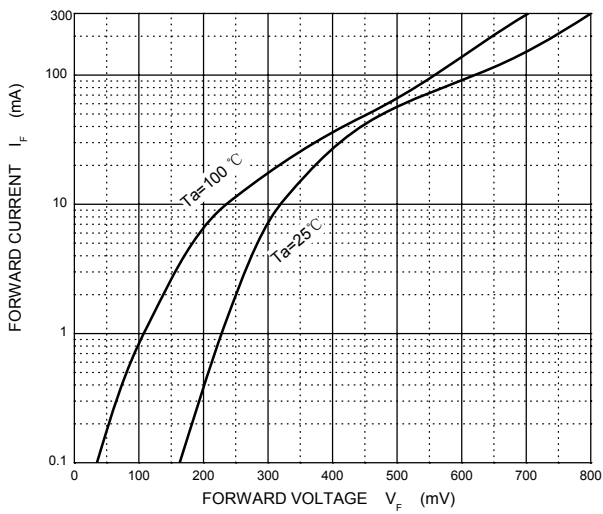

Reverse Characteristics

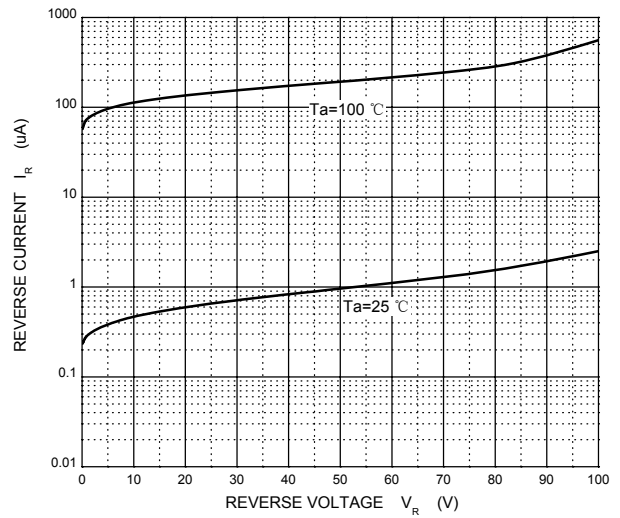

Capacitance Characteristics

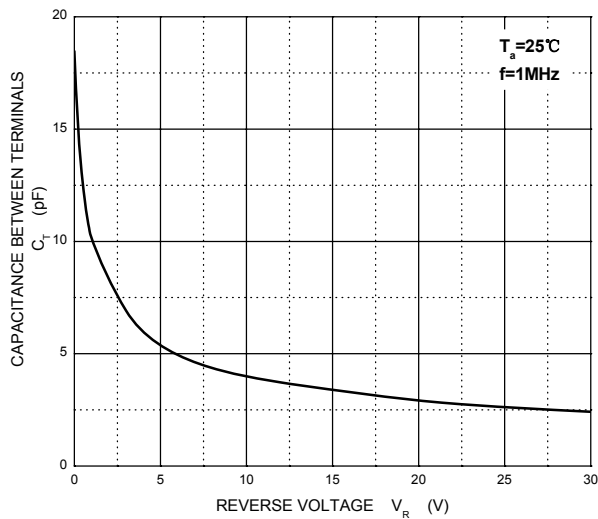

Power Derating Curve

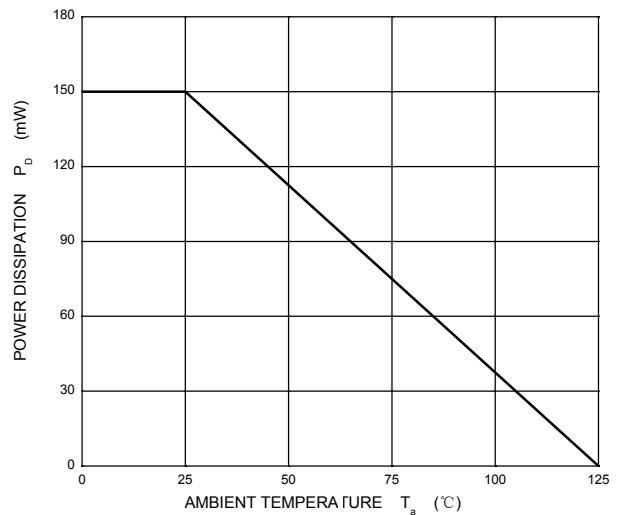



CHINA BASE
INTERNATIONAL

SOD-523

BAT46X



www.china-base.com.hk

PACKAGE OUTLINE

Plastic surface mounted package; 2 leads

SOD-523

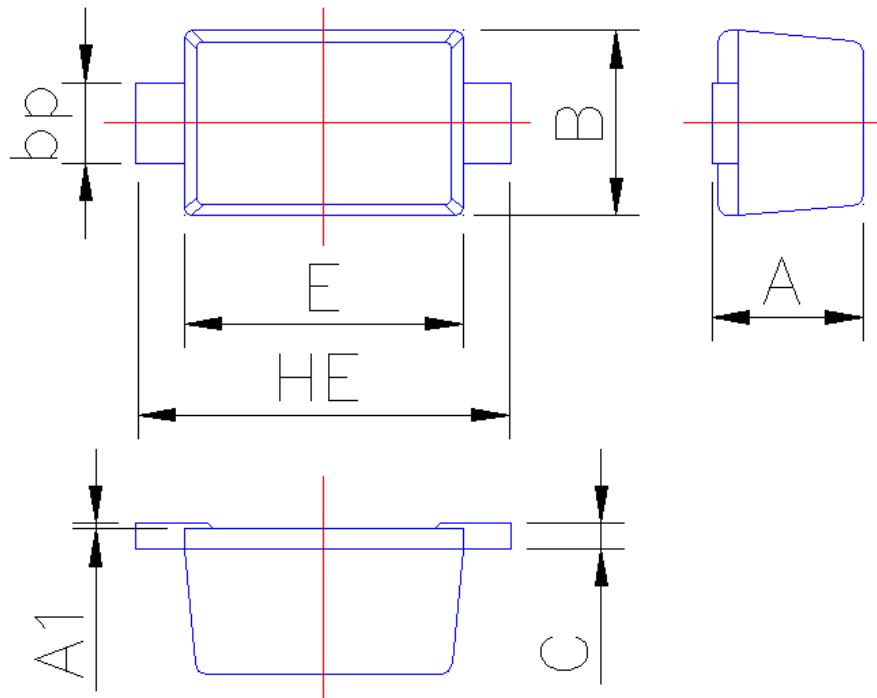

Symbol	Dimension in Millimeters	
	Min	Max
A	0.60	0.70
A1	0	0.05
B	0.75	0.85
bp	0.25	0.40
C	0.09	0.15
E	1.15	1.25
HE	1.50	1.70